

10 Step Guide for Effective StoreBoard® Graphics

By Douglas B. Leeds



“The only way around
is through.”

– ROBERT FROST

This guide is by **Douglas B. Leeds**, past Chairman/CEO of Thomson-Leeds Company, which under his leadership won more awards (POPAl) for effective in-store communications than any company in the world. Douglas is one of the founders of StoreBoard® Media and currently is Chief Executive of the company.

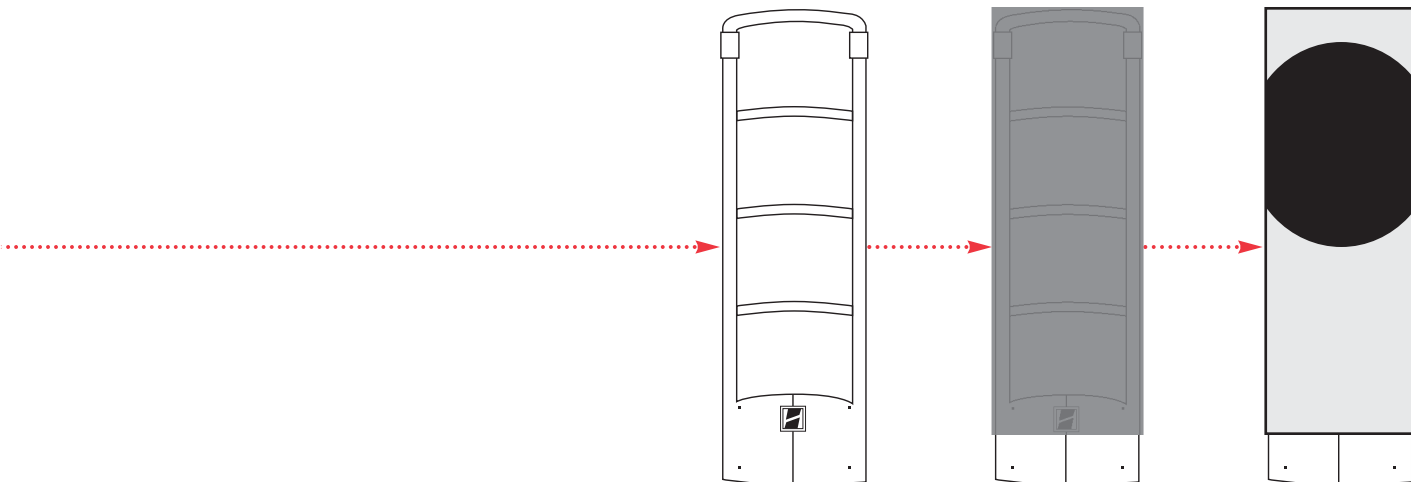

Few advertising options offer the pure retail excitement and brand endorsement that StoreBoard® ads command. StoreBoard's® messages greet every consumer who enters our retail partner stores.

Each advertising medium is different and has its own special characteristics. This guide was put together to help our advertisers better understand how best to utilize the vertical space of our boards to engage customers.

StoreBoards® reach people who are actively looking for information; they are on their feet, not casually sitting watching television or driving by a highway billboard. The visual presentation on each StoreBoard® is everything and the more simple it is, the more effective your message will be. The right design will build brand awareness at an optimal moment ... when consumers are near the moment of a purchase decision. We like to say, “instead of being miles away, StoreBoards® are only aisles away.”

An average of three 2-sided StoreBoards® are located at the entrance of most chain stores. Each is generally 60" tall by 24" wide. The repetition of three or more of the same brand billboards adds clarity and impact to your messages and actually reduces clutter in the front of the store.

TABLE OF CONTENTS

We recognize that most brands have a unique way of communicating their own message. If you consider the following suggestions **(the first three being the most important)**, you will surpass your expectations for effectively communicating to consumers at this unique out-of-home advertising location.

- 
- A red dotted arrow points from the left edge of the page towards the first item in the list.
- 1** SIMPLE/BOLD visuals grab attention. 6
 - 2** MAIN MESSAGE should be at eye level. 8
 - 3** FEW WORDS – focus quickly on a singular message. 10

 - 4** Keep type fonts BOLD and CLEAN. 12
 - 5** The Western world reads in a Z PATTERN. 12
 - 6** BRIGHT and LIGHT backgrounds often work best. 13
 - 7** Words such as NEW, INTRODUCING or IMPROVED work. 13
 - 8** Don't forget the RETAIL STAFF. 14
 - 9** Visit StoreBoard® Media ONLINE. 14
 - 10** HAVE FUN! Be imaginative. Be bold. 15

1

SIMPLE/BOLD visuals grab attention.

If you have a main message or product ... make that the HERO/STAR of your ads.

You've probably invested heavily in your package or logo design ... **use it Super-Size it ... even bleed your message or graphics off the board when appropriate.**

Showing a single product or message is usually more effective than showing multiple products or messages on a billboard. Let the consumer narrow their choice and make a final purchase selection.

“Make it simple. Make it memorable. Make it inviting to look at. Make it fun to read.”

– LEO BURNETT

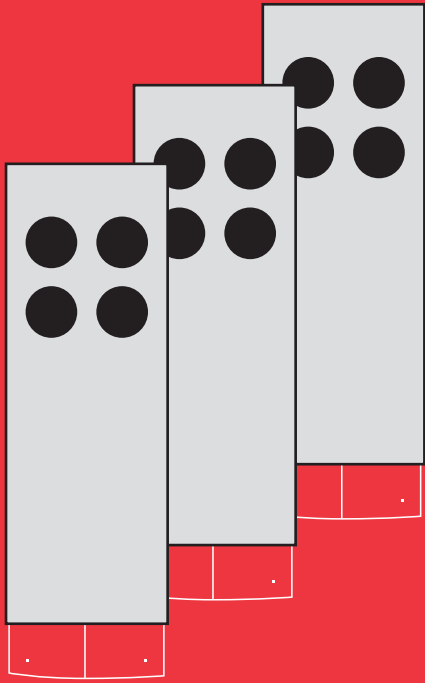

Good.

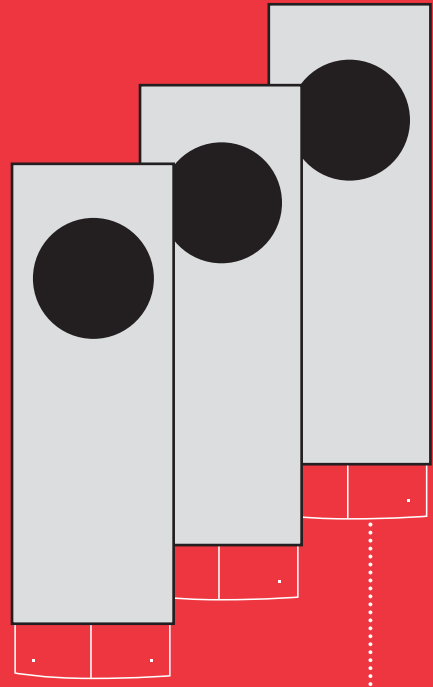

Better.

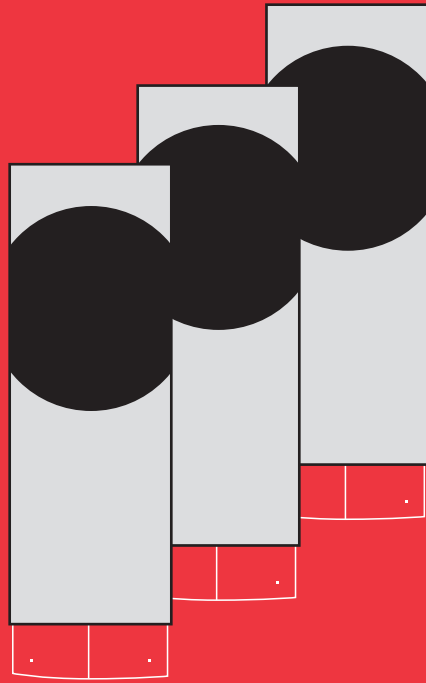

Best.



“On the average, five times as many people read the headline as read the body copy. When you have written your headline, you have spent 80 cents out of the dollar.”

– DAVID OGILVY

MAIN MESSAGE should be at eye level.

One of the key considerations is that though StoreBoards® average 60" tall, the average walking consumer is 67" tall – causing an almost perfect eye-level opportunity to view the main message.

Think of StoreBoards® as being divided into **three parts.**





▶ **The top is at eye level.** This is where you are more likely to catch attention. The main message here **MUST** be easy to absorb in a single glance.

The middle has supporting info for those interested in the main message. It should include quick bursts of essential information.

The bottom simply supports info in the middle. This is often a good place for your company's name or familiar logo.

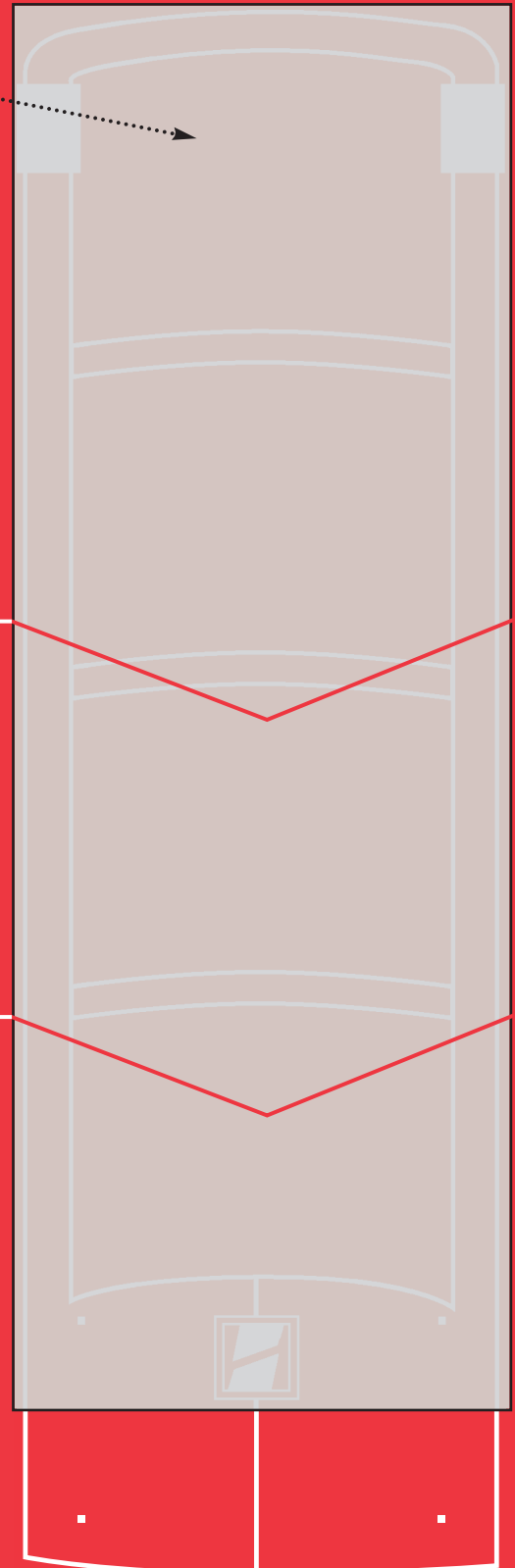

3

FEW WORDS – focus quickly on a singular message.

The best poster and billboard advertisements exercise “The Art of Brevity” – **one visual and no more than three or five words, preferably fewer.**

Research from OAAA (Outdoor Advertising Association of America) confirms that the most successful billboards are nonverbal. Cut out all extraneous words and pictures. **Concentrate on essentials.** When possible, use a photo or package to convey your message.

If you can, crop your photos and symbols to “**heroic**” proportions. Perhaps instead of a full-length figure, try just showing the upper body or the head. Even better, choose only the eyes.

“A StoreBoard® is finished when you can’t find a single element to remove.”

– DOUGLAS B. LEEDS

This is really truly great no matter what you say or do.
This is really truly great no matter what you say or do.
This is really truly great no matter what you say or do.

Good.

This is great no matter what you do.
This is great no matter what you do.
This is great no matter what you do.

Better.

This is GREAT!
This is GREAT!
This is GREAT!

Best.

4



Keep type fonts **BOLD** and **CLEAN**.

In-store advertising must visually cut through a cluttered environment of multiple colors and messages.

5

The Western world reads in a **Z PATTERN**.

Graphics should follow the **Z eye pattern** for a quick read.

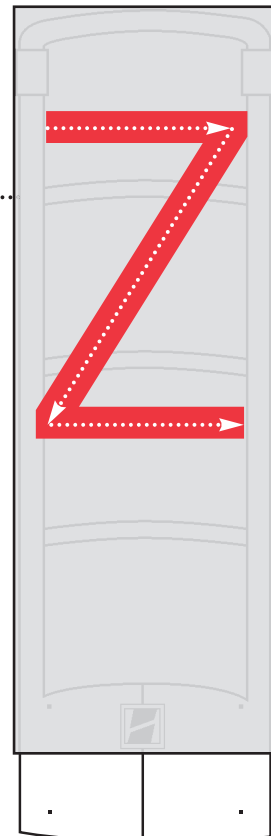

6

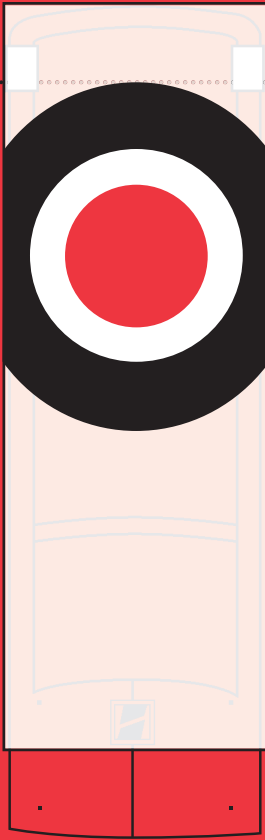

BRIGHT and LIGHT backgrounds often work best.

Choose **colors with contrast** in both hue and value. Contrasting colors are viewed well from a distance, while low-contrast colors will blend together and obscure a message.

Research from the OAAA states that “**high color contrast can improve outdoor advertising recall by 38 percent.**”

7

Words such as NEW, INTRODUCING or IMPROVED work.

Although used often, they remain magical when consumers are in retail environments. Use when appropriate to increase shopper curiosity and attract attention.

8



Don't forget the RETAIL STAFF.

The employees (pharmacists, store managers, cashiers, etc.) in the store may never see your commercials on TV but will notice your StoreBoard® message many times each day for a solid month. When appropriate, make sure the message is relevant to them.

9

Visit StoreBoard® Media ONLINE.

See actual in-store photos and different graphic treatments that work at www.StoreBoards.net

Also, call us – **we are always available** to assist you. The clearer your message, the happier we all will be.

10



HAVE FUN! Be imaginative. Be bold.

Catch attention and add to the excitement of communicating at the entrance of thousands of chain retail stores nationwide.

“I honestly believe that advertising is the most fun you can have with your clothes on.”

— JERRY DELLA FEMINA

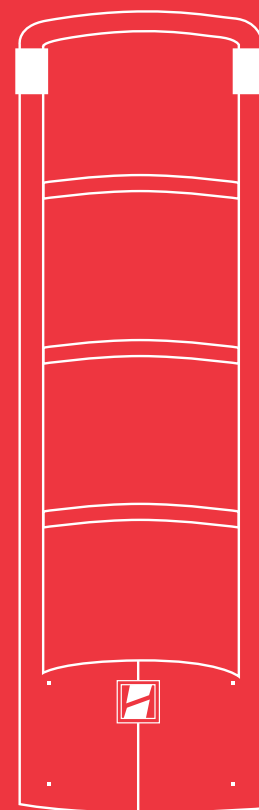
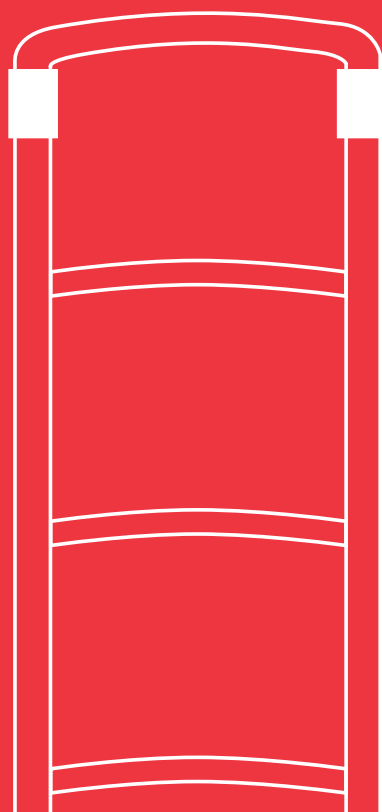
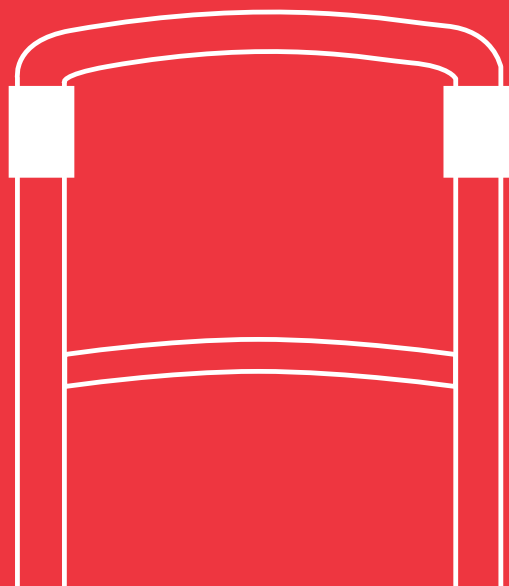



www.StoreBoards.net

A 10 Step Guide for Effective StoreBoard® Graphics

Copyright® 2009 by Douglas B. Leeds. All rights reserved.



This guide is printed on recycled paper. All StoreBoard® materials used in our retail partner stores are also printed on recycled paper and such is identified at the bottom of each StoreBoard®.